









KENMERKEN / FEATURES / MARKMALE

	HL-190 E12	HL-220 E12	HL-220 E12 N
H (max.)	± 18.80 m	± 21.50 m	± 21.50 m
H* (max.)	--	--	± 21.74 m
A (max.)	± 16.80 m	± 19.50 m	± 19.50 m
C (min.)	± 2.24 m	± 2.58 m	± 2.58 m
DxF (min.)	3.38 x 1.16 m	3.38 x 1.16 m	3.38 x 1.16 m
ExF (max.)	4.88 x 1.36 m	4.88 x 1.36 m	4.88 x 1.36 m
H1	3.40 m	3.74 m	3.74 m
H3	2.65 m	3.01 m	3.01 m
LxB	3.74 x 1.20 m	4.05 x 1.26 m	4.05 x 1.26 m
G	2.67 m	2.67 m	2.67 m
M/N	148 mm/235 mm	148 mm/235 mm	148 mm/235 mm
∅ D	± 3.92 m	± 00 0	± 00 0
 (max.)	500 kg (2 pers. + 340kg)	500 kg (2 pers. + 340kg)	500 kg (2 pers. + 340kg)
 (max.)	500 kg (2 pers. + 340kg)	500 kg (2 pers. + 340kg)	500 kg (2 pers. + 340kg)
 (sec.)	74/53 sec.	90/55 sec.	90/55 sec.
	2.0 km/h	2.0 km/h	2.0 km/h
	0.5 km/h	0.5 km/h	0.5 km/h
	22 x 9 x 16	22 x 9 x 16	22 x 9 x 16
 (max.)	± 25%	± 20%	± 20%
	420 Ah/k5/48 V	500 Ah/k5/48 V	500 Ah/k5/48 V
	7.985 kg	9.800 kg	9.800 kg

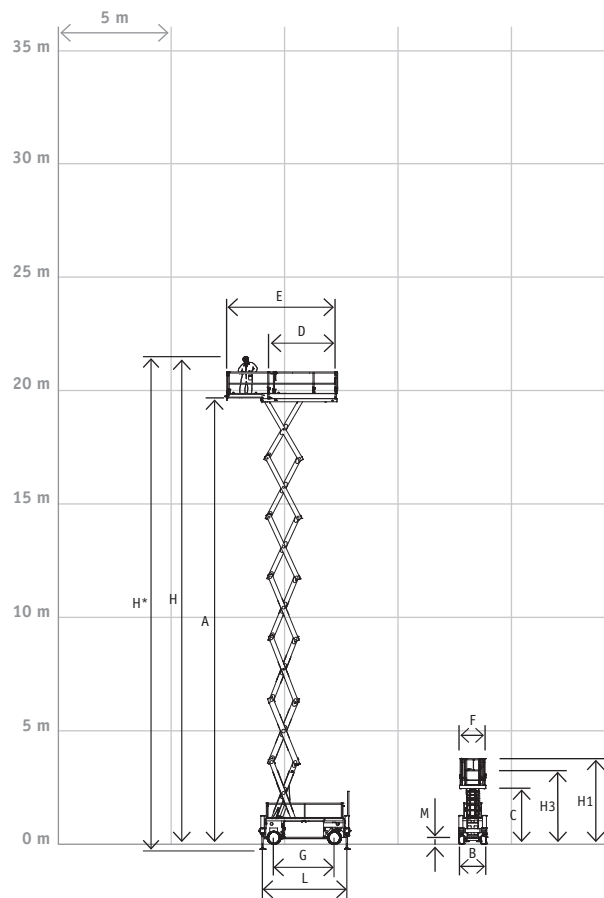

NEDERLANDS

ENGLISH

DEUTSCH

OPTIES

OPTIONS

OPTIONEN

Besturing met snelsluitstekker	Controlbox with quick disconnect	Plattformsteuerung mit Schnellstecker	●	●
Urenteller	Hourmeter	Stundenzähler	●	●
Lader (hoogfrequent)	Charger (high frequency)	Ladegerät (Hochfrequenz)	●	●
230V voorziening op platform	230V supply on platform	230V Versorgung an der Plattform	●	●
Rijden op volle hoogte	Driving at full height	Fahren in voller Höhe	●	●
Rijden, proportioneel	Driving, proportional	Fahren, proportional	●	●
Sperfunctie	Differential lock	Differentialsperre	●	●
Smeersysteem Easy Lube	Lubrication system Easy Lube	Schmiersystem Easy Lube	○	●
Smeersysteem Auto Lube	Lubrication system Auto Lube	Schmiersystem Auto Lube	○	○
Nivelleerstempels (N)	Levelling jacks (N)	Nivellierstützen (N)	●	○

VEILIGHEIDSVORZIENINGEN

SAFETY FEATURES

SICHERHEITSEINRICHTUNGEN

Beschermhek	Scissor skirt	Schutzgitter	●	●
Daalbeveiliging	Descent safety	Senkschutz	●	●
Flitslampen	Flashing beacons	Blinkleuchten	○	○
Rij-alarm (akoestisch)	Drive alarm	Fahrwarnung (akustisch)	●	●
Nooddaalvoorziening	Emergency descent	Notsenkvorrichtung	●	●

TOEPASSING

APPLICATION

ANWENDUNG

Voor gebruik in gesloten ruimten	Indoors	In geschlossenen Räumen	●	●
Voor gebruik buiten	Outdoors	Im Freien	--	●
Toelaatbare min. omgevingstemperatuur	Certified min. temperature	Zul. Tiefsttemperatur	-15°C	-15°C