

# BILLENNIUM QUICK-PRO

CRAWLER TELESCOPIC SPIDERBOOM

PATENT PENDING

## B1890 EVO



**ALMACRAWLER** 

# BILLENNIUM B1890 QUICK-PRO

**VERSATILITY  
EFFICIENCY  
CREATIVITY  
AGILITY**

The Billennium Line features morphologically unique models to provide a superior user experience and greater market adaptability for the real needs of the rental and end-users sector alike.

The new Line is characterized by its unique automatic stabilization systems. There are two different types of stabilization: VISUAL with a single fixed area and the innovative Quick-PRO, a fully automated stabilization system with six different combination.



**18mt.**  
working  
height

*A new concept  
to work at height...  
The SpiderBoom!*

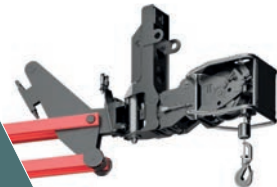

**WINCH  
KIT  
200 KG**

**1.4 mt BASKET  
STANDARD**



**1.8 mt BASKET  
OPTIONAL**



**BASKET  
SIZE**

OPTIONAL

**TASKET  
RESIZABLE BASKET  
DISMOUNTING NOT REQUIRED**

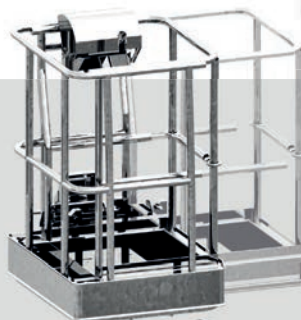

780 →  
1200 →

A resizable basket that allows the operator to manually extend the basket sideways.

The Tasket Basket by AlmaCrawler is the only two-operator basket that does not require disassembly to go through narrow passages, extending from a minimum width of 0.78 m to a full 1.20 m.



# XXL

ULTRA EXTENDABLE  
UNDERCARRIAGE  
SIZE "XXL"



With a width of 1,39 m, a length of 2.15 m and a height of 0,47 m, these tracks are the longest and widest on the market.

Their size increases the operator's safety when travelling over rough and sloping terrain.

# ATS

AUTOMATIC  
TENSIONER  
SYSTEM

The track tensioning system is a hydraulic cylinder directly connected to and controlled by the main hydraulic system.

The system creates **zero maintenance** because it ensures the constant and correct tensioning of the track itself.



The SPS system is what allows the use of the Billennium Spiderbooms even without lowering the stabilizers, levelling longitudinally up to a maximum of 10° with a maximum working height of 9 m (max lateral slope 5°).

This is made possible by the seamless technological mix of proactive and dynamic levelling, the XXL undercarriage and an automatic hydraulic longitudinal levelling of the basket.



# SPS

SELF-PROPELLED  
SKILL SYSTEM

PATENT PENDING

EXTRA  
OUTREACH



This system calculates the stabilization area in real time by measuring the angle of descent of each individual stabiliser in order to optimise the operational outreach performance over the entire working area up to an extra 0.5 m.

# AWP

ADAPTIVE  
WORKING  
PERFORMANCE

PATENT PENDING

**Technical data**
**EVO**

Max working height	18,00 m
Max height basket floor	16,00 m
Moving height	9,00 m
Max outreach (load 80 kg)	10,9 m
Max outreach (load 140 kg)	9,8 m
Max outreach (load 200 kg)	8,8 m
Max outreach (load 230 kg or 250 kg)	8,1 m
Rotation angle	+/- 185°
Basket size	1,4 x 0,74 m
Basket rotation angle	+/- 70°
Max basket capacity	250 Kg
Length in stowed position (with detached basket)	5,84 m (5,14 m)
Min width in stowed position	0,79 m
Working width on tracks	1,39 m
Min height in stowed position	1,98 m
Longitudinal leveling by SPS	+/- 10°
Max lateral inclination with SPS	+/- 5°
Max gradeability	20°
Max side gradeability	+/- 5°
Maximum stabilisation area	3,56 m x 4,97 m
Stabilisation	Quick-PRO
Drive speed (fast)	2,5 Km/h
Security speed	0,4 Km/h
Non-marking tracks	Yes
Cable Remote LED Console or DISPLAY	Yes
ATS, AWP, SPS	Yes
Removable pads	Yes

**Weights**

Total weight	~2930 Kg
--------------	----------

**Power**

Main Power Source	YANMAR 2TNV70 10.2 kW (13.9 HP) @ 3600 rpm
Hydraulic gearmotors	Yes
Electric gearmotors	No
N°2 battery charger 20Ah-48 V	No

**Extras - On Demand**

Tasket Basket	0,78 (1,20) x 0,7 m
Wide Basket	1,8 x 0,7 m
Motore Hatz 1B40	No
Eletric pump 220V-2,2KW / 50Hz (Weight +30 Kg)	Yes
Radio remote display or led control	Yes
Arctic lubricant for cold climate	Yes
Winch Kit Series 200 kg	Yes
Anticollision System	Yes
Customized powder coating (One Special Colour + BLACK 9005)	Yes

**CONTROL DEVICE**

Available on all models: LED or DISPLAY radio or remote console. Both versions have been designed to be user-friendly and allow proportional joystick driving.

**LED**

**DISPLAY**

Simplify and centralize the management of all after sales activities, spare parts purchasing and warranty procedures.

Providing 24/7 access to all technical documents and tools for daily management.

Manage all your ALMAC products in one single online portal.

**MYALMAC CONTROL PANEL**

# QUICK-PRO

## 6 COMBINATIONS AUTOMATED STABILIZATION SYSTEM

Fully Automated Stabilization with Variable Areas which offers 6 different machine positioning combinations, simple to choose through the appropriate selector; by automatically interacting with the AWP system, it guarantees the operator the best possible outreach performance.



QUICK-PRO  
SELECTOR

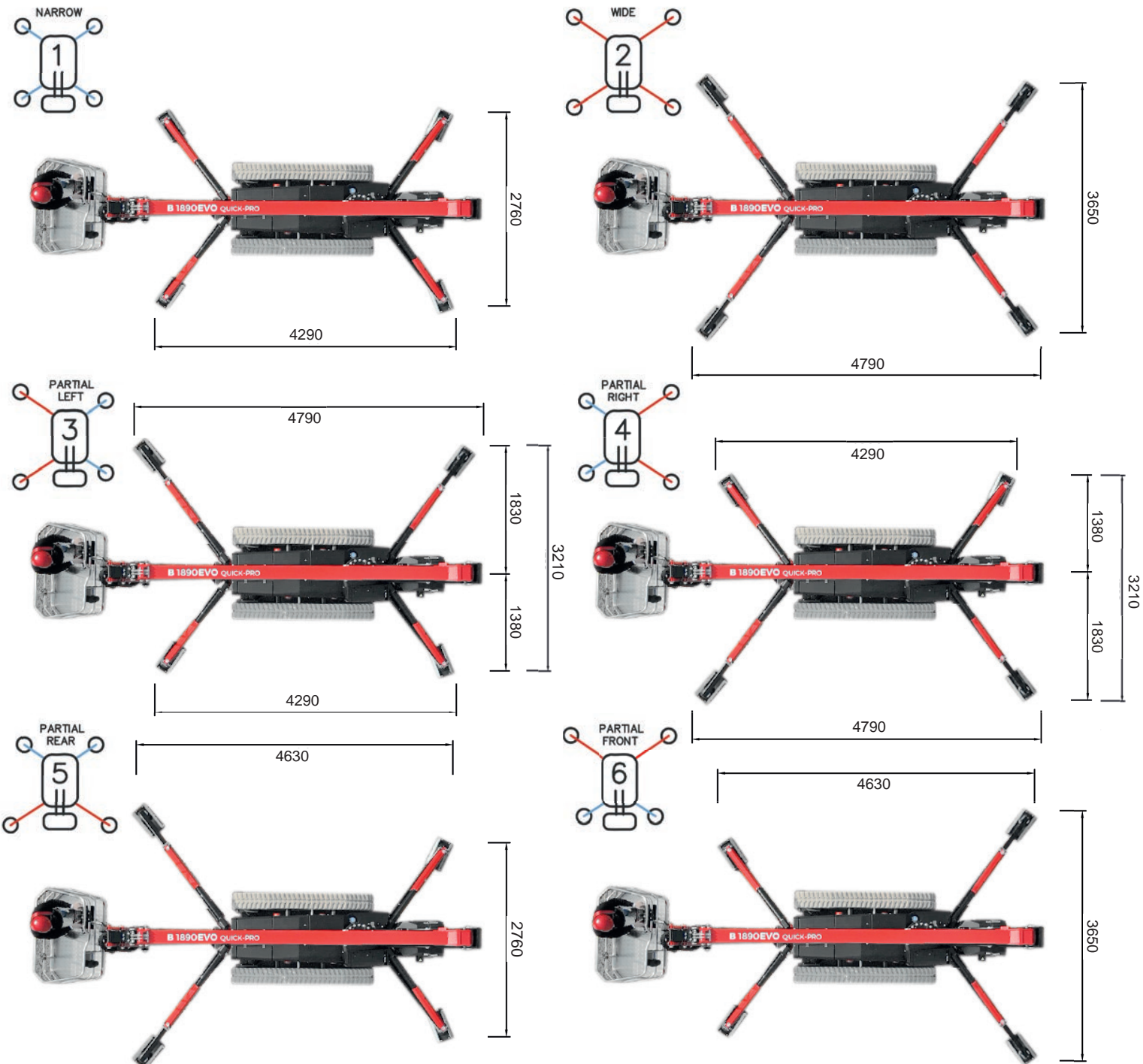



# B1890 QUICK-PRO

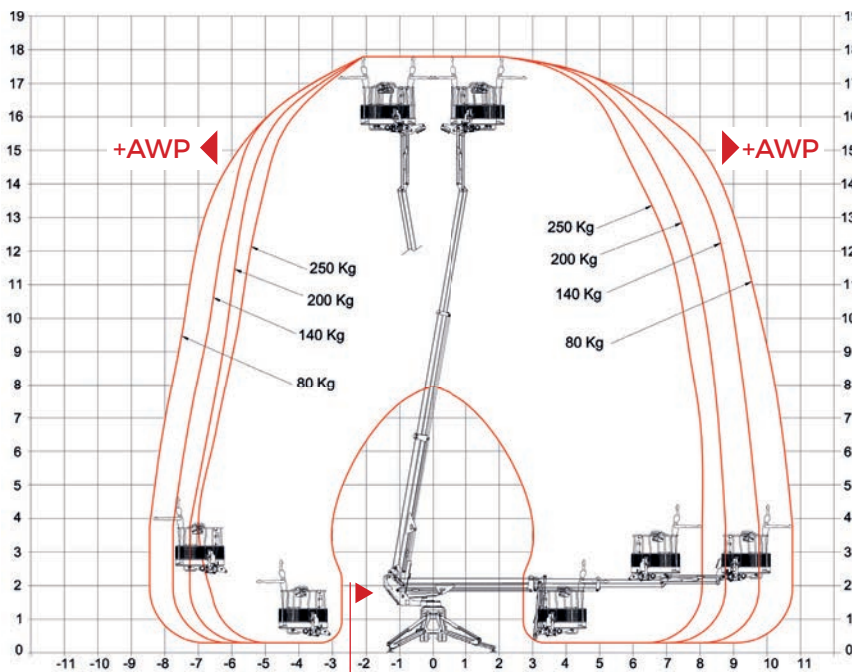
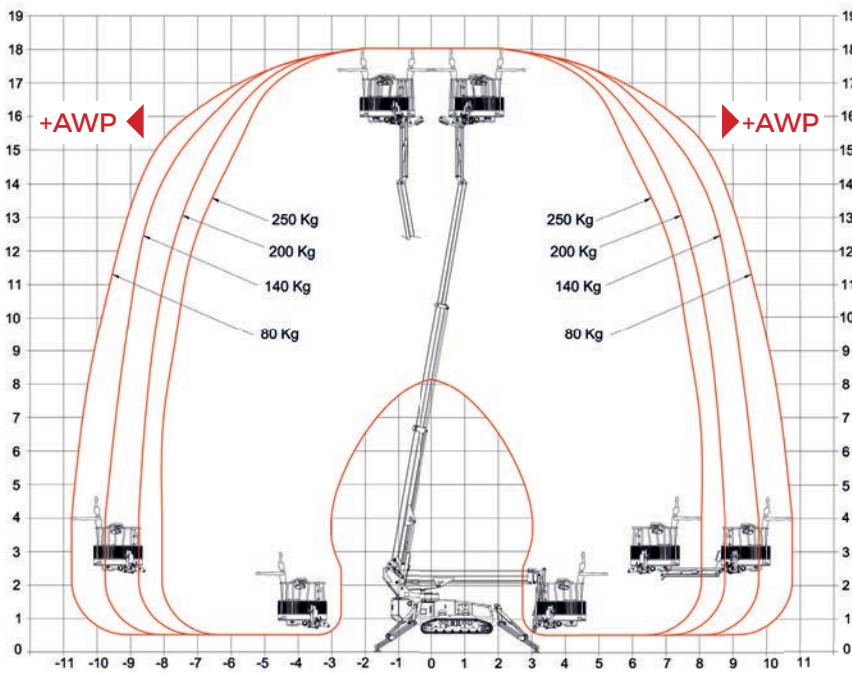
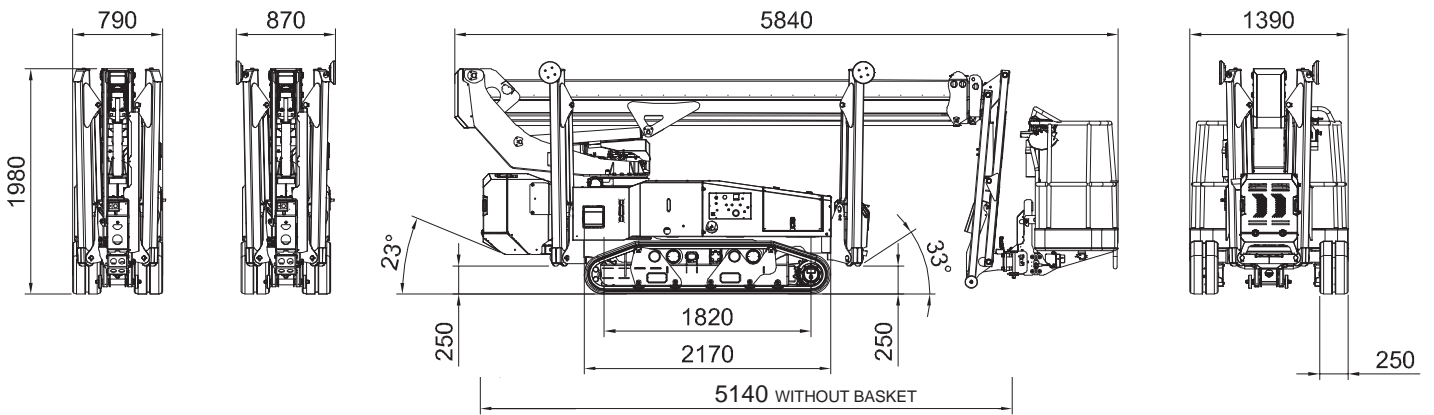

Zero tail swing

## AWP

ADAPTIVE WORKING PERFORMANCE

PATENT PENDING

EXTRA OUTREACH

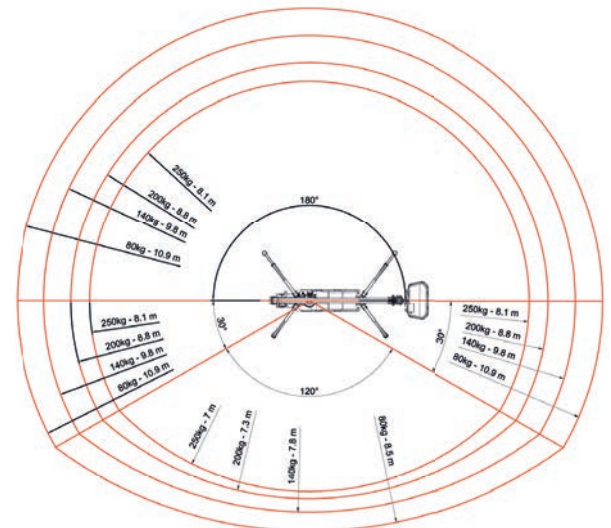

**ALMACRAWLER**

Via Caduti sul Lavoro 1  
46019 Viadana (MN) - ITALY  
+39 0375 83 35 27  
info@almac-italia.com  
www.almac-italia.com